

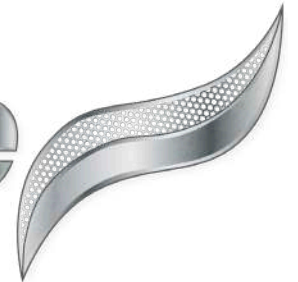

*ExtraStove*



Pellet products  
2024/25





# La nostra Azienda

## About Us

## Nuestra Empresa

ExtraStove è un'azienda interamente italiana creatrice di tecnologie e prodotti per riscaldamento a biomassa. La grande esperienza nel settore metalmeccanico abbinata all'esperienza acquisita nel settore del riscaldamento pongono ExtraStove in una posizione di rilievo nel mercato europeo. ExtraStove si è distinta come azienda leader nel settore del riscaldamento a pellet, con la garanzia di elevati livelli qualitativi ed esporta ormai da anni con successo la propria tecnologia e design in oltre 30 paesi.

Per questo il marchio ExtraStove è diventato ormai un sinonimo di affidabilità a bassi consumi.

*ExtraStove is an Italian company that develops and manufactures biomass heating technologies and products. Its vast experience in the engineering industry combined with the experience gained in the field of heating have elevated ExtraStove to a position of prominence on the European market. ExtraStove has distinguished itself as a leader in the field of pellet heating, ensuring high quality levels, and has been exporting its technology and design in over 30 countries for several years now.*

*That is why the ExtraStove brand has become synonymous with reliability and low energy consumption.*

ExtraStove es una empresa completamente italiana creadora de tecnologías y productos para calefacción a biomasa. La gran experiencia en el sector metalmeccánico combinada con la experiencia adquirida en el sector de la calefacción colocan a ExtraStove en una posición relevante en el mercado europeo. ExtraStove se ha distinguido como empres líder en el sector de la calefacción a pellet, con la garantía de elevados niveles cualitativos y exporta ya desde años con éxito su tecnología y design a más de 30 países.

Por esto la marca ExtraStove se ha convertido en un sinónimo de fiabilidad a bajos consumos.





# Design e produzione 100% Made in Italy

*Design and production 100% Made in Italy*

## Design y producción 100% Made in Italy

I prodotti ExtraStove sono 100% prodotti in Italia, affidabili e resistenti nel tempo perchè vengono costruiti interamente all'interno della nostra fabbrica da personale qualificato che ne cura tutti i particolari nelle fasi di costruzione.

Oggi la stufa è sempre più un vero e proprio elemento d'arredo. Per questo ExtraStove offre un'ampia gamma di modelli e potenze ma soprattutto propone le soluzioni più adatte per ogni tipologia di ambiente, moderno o classico che esso sia, ponendo particolare attenzione alla scelta dei materiali, dei rivestimenti e di ogni particolare mantenendo alta la tradizione italiana per il gusto estetico.

*ExtraStove products are 100% made in Italy, and are reliable and durable because they are manufactured entirely in our factory by qualified staff that takes care of all the details across all stages of construction. Today the stove is more and more a real piece of furniture. Which is why ExtraStove offers a wide range of models and power outputs, but above all offers the best solutions for every type of environment, whether it be modern or classic, paying particular attention to the choice of materials, finishes and every detail, continuing the Italian tradition for aesthetic taste.*

Los productos ExtraStove son 100% producidos en Italia, fiables y resistentes en el tiempo porque son construidos completamente en nuestra fábrica por personal calificado que cuida todos los particulares durante las etapas de construcción.

Hoy la estufa es cada vez más un verdadero y propio elemento de decoración. Por esto ExtraStove ofrece una amplia gama de modelos y potencias pero sobre todo propone las soluciones más adaptadas para cada tipo de ambiente, moderno o clásico que este sea, prestando particular atención a la selección de los materiales, de los revestimientos y de cada detalle manteniendo en alto la tradición italiana por el gusto estético.

# 100%



## MADE IN ITALY





EN 14785  
EN 303-5

TÜVRheinland



# Sicurezza certificata, un sinonimo di qualità !

*Certified safety = Guaranteed quality!*

¡Seguridad certificada , un sinónimo de calidad!

Ogni prodotto ExtraStove è testato con prove reali di utilizzo e certificato rispettando le più rigorose normative a livello internazionale.

ExtraStove produce le proprie stufe in conformità alle normative europee EN 14785 ed EN 303-5. Tutti i prodotti sono certificati dal rigoroso istituto tedesco "TUV Rheinland" ed adottano le migliori soluzioni tecnologiche brevettate a livello internazionale.

Dopo aver superato rigidi controlli i prodotti ExtraStove ricevono le più importanti certificazioni tra le quali il: TÜV, 15a BV-G, BlmSch2, BAFA, ect. ect. e possono così usufruire delle detrazioni fiscali in vigore nei diversi paesi.

*Each ExtraStove product is tested and certified in compliance with the strictest international standards.*

*ExtraStove manufactures its own stoves in accordance with European standards EN 14785 and EN 303-5. All products are certified by the rigorous German Institute "TUV Rheinland" and adopt the best, internationally patented technological solutions.*

*After passing strict controls, ExtraStove products receive the most important certifications such as: TÜV, 15a BV-G, BlmSch2, BAFA, etc. and are eligible for tax deductions in several countries.*

Cada producto ExtraStove es probado con test reales de utilización y certificado respetando las más rigurosas normativas a nivel internacional.

ExtraStove produce sus estufas en conformidad con las normativas europeas EN 14785 y EN 303-5. Todos los productos son certificados por el riguroso instituto alemán "TUV Rheinland" y adoptan las mejores soluciones tecnológicas patentadas a nivel internacional.

Después de haber superado rígidos controles los productos ExtraStove reciben las más importantes certificaciones entre las cuales el: TÜV, 15a BV-G, BlmSch2, BAFA, ect. ect. y pueden así usufructuar de las desgravaciones fiscales en vigor en los distintos países.

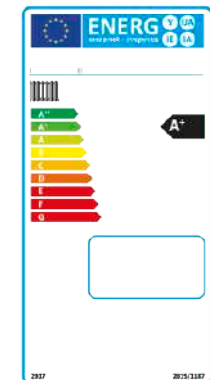



# Ricerca & Sviluppo - Supporto & Assistenza

*Research & Development - Customer service & Technical support*

## Investigación & Desarrollo - Soporte & Asistencia

La grande attenzione rivolta all'utilizzo di energie rinnovabili ha permesso ad ExtraStove di sviluppare notevolmente negli anni la propria produzione investendo in ricerca & sviluppo per prodotti sempre più corrispondenti alle esigenze moderne. Ogni prodotto ExtraStove è frutto di attenti studi che vanno dalla progettazione iniziale al collaudo finale.

ExtraStove fornisce inoltre un accurato servizio di assistenza tecnica. I nostri tecnici lavorano costantemente con l'obiettivo di migliorare la qualità, le prestazioni e la sicurezza dei prodotti per fornire soluzioni innovative ed affidabili.

*Its focus on the use of renewable energy has allowed ExtraStove to expand its production considerably over the years, investing in Research & Development to build products that increasingly meet modern requirements.*

*Each ExtraStove product is the result of careful studies ranging from the initial design to final testing.*

*ExtraStove also provides an accurate technical support service. Our engineers are constantly working to improve the quality, performance and safety of the products, in order to provide innovative and reliable solutions.*

La gran atención dirigida a la utilización de energías renovables ha permitido a ExtraStove desarrollar notablemente durante años su producción invirtiendo en investigación & desarrollo para productos cada vez más correspondientes con las exigencias modernas.

Cada producto ExtraStove es fruto de cuidadosos estudios que van desde el diseño inicial hasta la prueba final.

ExtraStove suministra además un cuidadoso servicio de asistencia técnica. Nuestros técnicos trabajan constantemente con el objetivo de mejorar la calidad, los servicios y la seguridad de los productos para suministrar soluciones innovadoras y confiables.



# Risparmio economico e rispetto dell'ambiente

*Savings and respect for the environment*

## Ahorro económico y respeto del ambiente

Le biomasse sono fonte di energia rinnovabile e consentono basse emissioni di CO<sub>2</sub> in atmosfera. Creare prodotti ecologici, per un comfort ancora più economico e sostenibile è il nostro obiettivo. Installare un prodotto a pellet è una scelta intelligente e duratura perchè risparmi facendo entrare in casa tua un sistema naturale. I prodotti a pellet costituiscono ormai uno dei più innovativi, ecocompatibili e vantaggiosi sistemi di riscaldamento. Grazie ai prodotti ExtraStove tecnologicamente performanti, per il riscaldamento domestico si può risparmiare fino al 50-60% della spesa rispetto ad altri combustibili.

*Biomass is a renewable source of energy that contributes to lower CO<sub>2</sub> emissions into the atmosphere. Creating environmentally friendly products, while ensuring an even cheaper and sustainable comfort, is our main goal. Installing a pellet-fuelled product is a smart and convenient choice, because you save on money, while introducing a all-natural system into your home. The pellet stoves are now one of the most innovative, environmentally friendly and affordable heating systems available on the market. Thanks to the technologically performing ExtraStove products, you can save up to 50-60% more than with conventional fuels, to heat up your home.*

Las biomásas son fuentes de energía renovable y permiten bajas emisiones de CO<sub>2</sub> en atmósfera. Crear productos ecológicos, para un confort todavía más económico y sostenible es nuestro objetivo. Instalar un producto a pellet es una decisión inteligente y duradera porque ahorras haciendo entrar en tu casa un sistema natural. Los productos a pellet constituyen ahora uno de los más innovadores, ecocompatibles y ventajosos sistemas de calefacción. Gracias a los productos ExtraStove tecnológicamente eficientes, para la calefacción doméstica se puede ahorrar hasta el 50-60% del gasto respecto a otros combustibles.

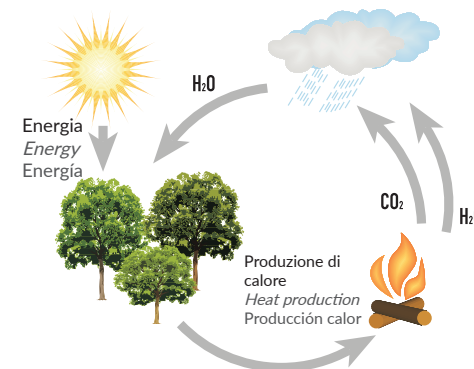

# Un'ampia gamma di modelli

*A wide range of models*

Una amplia gama de modelos

STUFE / STOVES / ESTUFAS

ER 11X

ESC 13

ER 13

ESA 13

ES 13

WO 135

ES 11

WO 115

ER 14  
ER 14C



pag. 10

12

14

16

18

20

22

24

26





PRODOTTI DA ESTERNO  
OUTDOOR LINE / PRODUKTOS PARA EXTERIOR

RT 145E  
RT 145EC

WO 70

BABY 5

AURA 9

FLAMMY  
7000

FLAMMY  
7000 PLUS

ALADINO  
4000

ALADINO  
4000 PLUS



28

30

32

34

36

38

40

40



# ER11 X

SEALED



kW 9



KG

kg 85

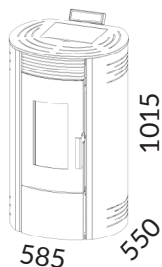

on request



Nero / *Black* / Negro    Bordeaux\* / *Bordeaux\** / Burdeos\*    Bianco / *White* / Blanco



Nessuna dispersione del calore grazie al corpo stufa ermetico completamente saldato.

*No heat loss thanks to the fully welded hermetic body of the stove.*

Sin pérdida de calor gracias al cuerpo de la estufa hermética totalmente soldado.



Approvato e testato per l'installazione tramite "tubi concentrici" (permette di effettuare l'aspirazione dell'aria e l'espulsione dei fumi in un unico condotto).

*Approved and tested for the "Concentric pipe" installation (it provides the advantage of performing suction and extraction in a single pipe/duct).*

Aprobado para la instalación a través de "tubos concéntricos" (permite la aspiración de aire y la expulsión de humos en un solo conducto).



\*Colore disponibile solo su richiesta

*\*Color available only on request*

\*Color disponible solo bajo pedido





# ESC 13



kW 10



KG

kg 75

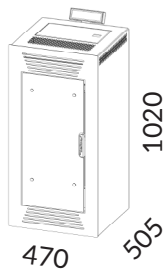

470

1020

505



on request



Bianco / White / Blanco

Nero\* / Black\* / Negro\*

Bordeaux\* / Bordeaux\* / Burdeos\*



Display LCD, con 15 programmazioni giornaliere e settimanali. Utilizzo semplice ed intuitivo.  
*LCD display with 15 daily and weekly programmes. Simple and intuitive use.*

Display LCD, con 15 programaciones diarias y semanales. Utilización fácil e intuitiva.



Elegante maniglia a scomparsa.  
*Elegant retractable handle.*  
Elegante manilla retráctil.



\*Colore disponibile solo su richiesta

*\*Color available only on request*

\*Color disponible solo bajo pedido

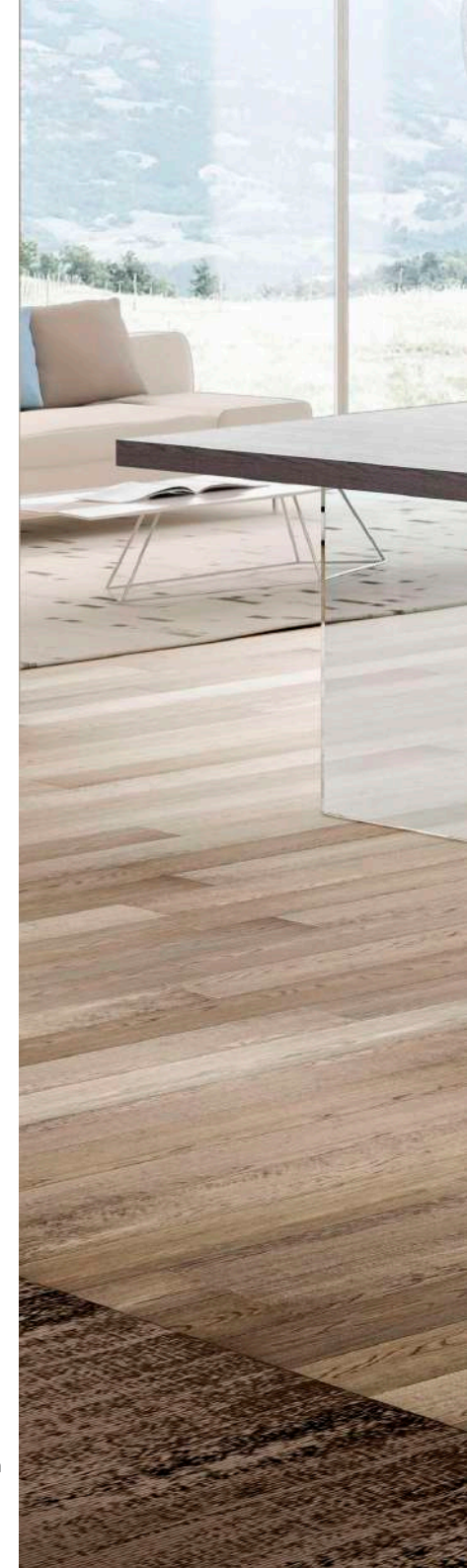



# ER 13



kw 10



kg 85

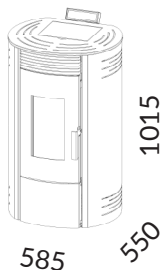

Nero / *Black* / Negro

Bordeaux / *Bordeaux* / Burdeos

Bianco / *White* / Blanco



Linea rotonda e armoniosa in grado di soddisfare ogni esigenza di arredo.

*A round and harmonious line that can satisfy all furnishing needs.*

Línea redonda y armoniosa capaz de satisfacer cada exigencia de decoración.



Scambiatore verticale a fascio tubiero, per una massima resa ed una combustione pulita ed efficiente.

*Vertical, tubular heat exchanger for maximum performance and a clean and efficient combustion.*

Intercambiador vertical multitubular, para un máximo rendimiento y una combustión limpia y eficiente.



\*Colore disponibile solo su richiesta

*\*Color available only on request*

\*Color disponible solo bajo pedido





# ESA 13



kW 10



kg 89

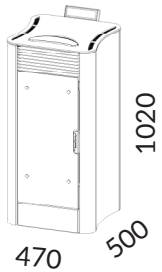

on request



Nero / Black / Negro



Serbatoio carico pellet scorrevole, con carica dall'alto per caricare agevolmente il pellet. Funzionale per un facile utilizzo.

*Pellet tank with sliding hatch; pellets are fed into the tank from the top. Functional for easy use.*

Depósito carga pellet corredizo, con carga desde arriba para cargar fácilmente el pellet. Funcional para una fácil utilización.

Design elegante con accurate rifiniture in acciaio satinato.

*Sleek design with intricate brushed steel finishes.*

Design elegante con cuidadosos acabados en acero satinado.







# ES 13



kW 10



kg 69

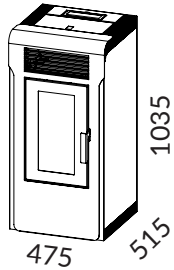

Nero / Black / Negro    Bordeaux / Bordeaux / Burdeos    Bianco\* / White\* / Blanco\*



Elegante display mobile a scomparsa.  
*Elegant and nice retractable display.*  
Elegante pantalla retráctil.



Capienza serbatoio 15 kg per poter sempre utilizzare un sacco completo.  
*Container capacity: 15 kg so that you can always use a full bag.*  
Capacidad depósito 15 kg, para poder utilizar siempre un saco completo.



\*Colore disponibile solo su richiesta  
*\*Color available only on request*  
\*Color disponible solo bajo pedido





# WO 135



KW 10



KG  
kg 77

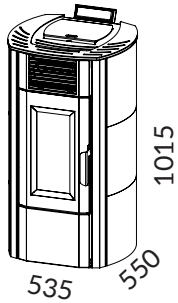

WiFi  
on request



Nero / *Black* / Negro



Bianco / *White* / Blanco



Bordeaux / *Bordeaux* / Burdeos



Basse emissioni di polveri garantite e certificate dai maggiori enti Europei.

*Low dust emissions guaranteed and certified by major European institutions.*

Bajas emisiones de polvos garantizadas y certificadas por los principales entes europeos.



Braciere rotondo per una combustione perfetta, estremamente pulita ed efficiente.

*Round brazier for ideal combustion, extremely clean and efficient.*

Brasero redondo para una combustión perfecta, extremadamente limpia y eficiente.





# ES 11



kW 8,5



kg 69

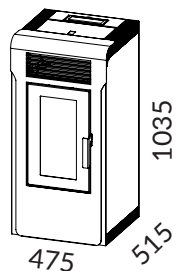

on request



Nero / Black / Negro    Bordeaux / Bordeaux / Burdeos    Bianco\* / White\* / Blanco\*



Pareti della camera di combustione in acciaio alluminato, per una cessione più rapida del calore grazie alla grande superficie di scambio più ampia.

*The walls of the combustion chamber are made of aluminised steel for faster heat transfer, thanks to the wider exchange surface.*

Paredes de la cámara de combustión en acero aluminato, para una cesión más rápida del calor gracias a la gran superficie de intercambio más amplia.



Vetro panoramico che lascia ampio spazio alla visione della fiamma.

*Panoramic glass that leaves plenty of room to view the flame.*  
Vidrio panorámico que deja amplio espacio a la visión de la llama.



\*Colore disponibile solo su richiesta

\*Color available only on request

\*Color disponible solo bajo pedido

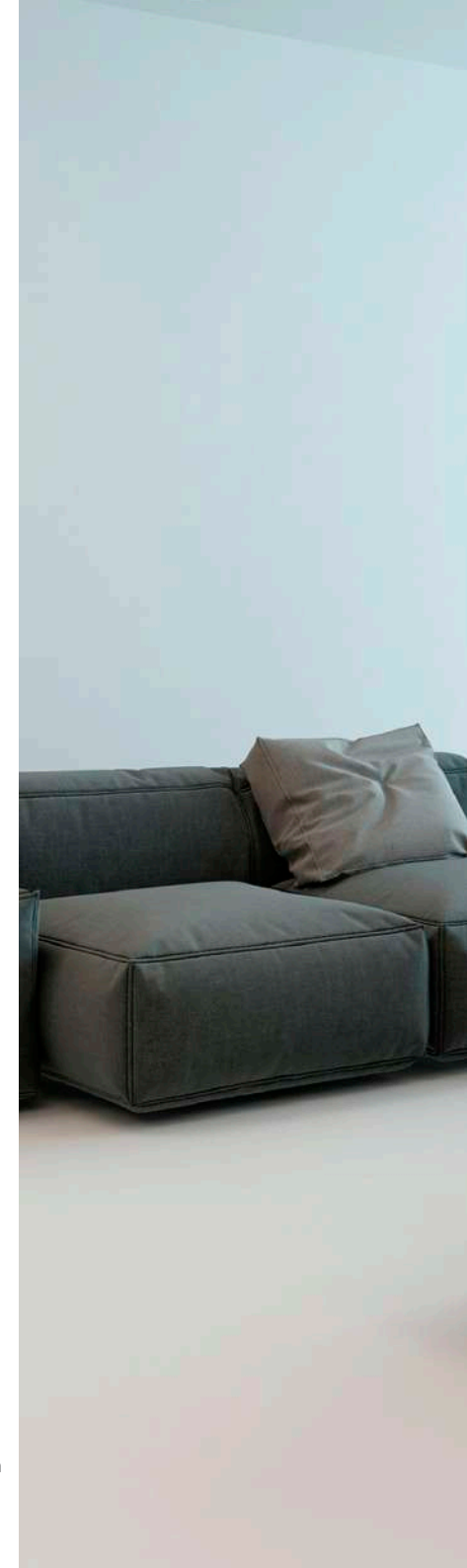



# WO 115



kW 8,5

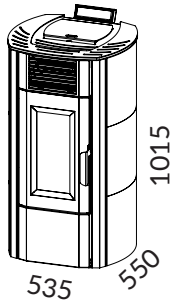

Nero / *Black* / Negro



Bianco / *White* / Blanco



Bordeaux / *Bordeaux* / Burdeos



Serbatoio pellet con griglia di sicurezza.  
*Pellet container with safety grate.*  
Depósito pellet con rejilla de seguridad.



Le stufe EXTRASTOVE sono dotate di telecomando.  
*Our EXTRASTOVE stoves are equipped with remote control.*  
Las estufas EXTRASTOVE están equipadas con mando a distancia.







# ER 14 / ER 14C



kW 12-11



kg 96-98

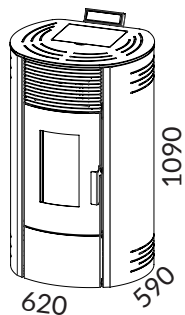

on ER 14C



on request



Nero / Black / Negro

Bianco / White / Blanco



Il modello ER 14C consente di riscaldare 3 ambienti contemporaneamente.

*The model ER 14C lets you heat 3 room/spaces simultaneously.*

El modelo ER 14C permite calentar 3 ambientes contemporáneamente.



L'ampio cassetto portacenere permette di evitare ripetuti interventi di svuotamento per un lunga autonomia.

*The large ashtray-drawer avoids the hassle of having to frequently empty it out for improved autonomy.*

El amplio cajón portacenizas permite evitar repetidas intervenciones de vaciado para una larga autonomía.





# RT 145E / RT 145EC



kW 12-11



kg 94 - 96

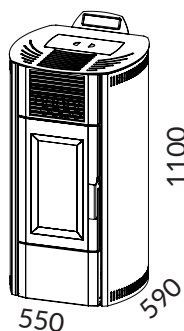

on RT 145EC



WiFi  
on request



Nero / Black / Negro



Bianco / White / Blanco



Bordeaux / Bordeaux / Burdeos



Display 7 tasti, funzionale e di facile utilizzo, con sistema "test componenti" incorporato.

*Display with 7 keys, functional and easy to use, with "component test" function inside.*

Display 7 teclas, funcional y de fácil utilización, con sistema "test componentes" incorporado.

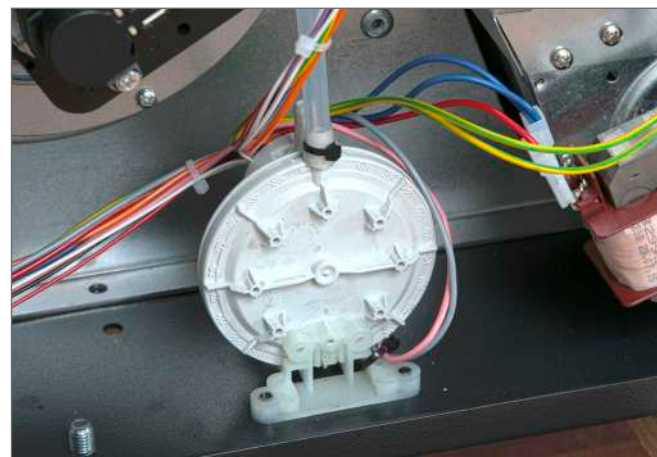

Pressostato di sicurezza affidabile e di qualità presente in ogni nostra stufa, per garantirne un perfetto funzionamento.

*Reliable, high-quality safety pressure switch on all our stoves to guarantee perfect operation.*

Presostato de seguridad confiable y de calidad presente en cada una de nuestras estufas, para garantizarle un perfecto funcionamiento.

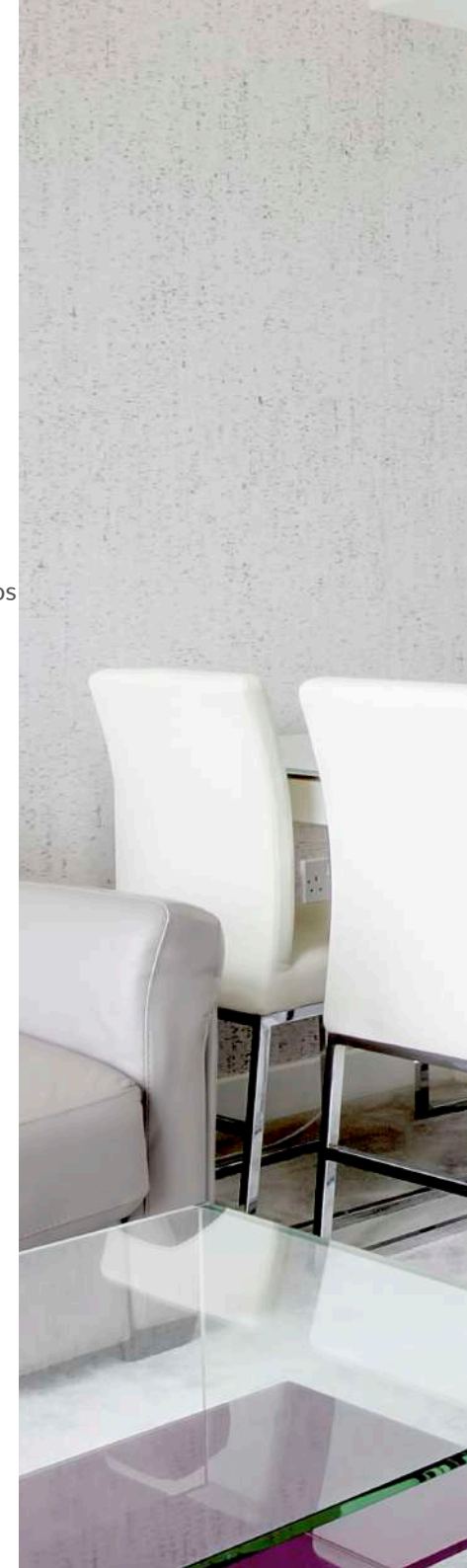



# WO 70



kW 7



kg 60

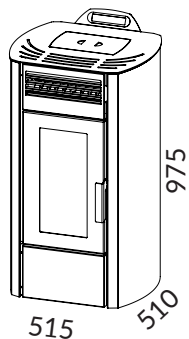

Nero / Black / Negro    Bordeaux / Bordeaux / Burdeos    Bianco / White / Blanco



Wo 70, compatta ma di qualità con elevato rendimento termico e dal funzionamento estremamente silenzioso.

*Wo 70, compact but with high thermal efficiency and extremely silent operation.*

Wo 70, compacta pero de calidad con elevado rendimiento térmico y de funcionamiento extremadamente silencioso.



Display 3 tasti, semplice ma funzionale con 2 programmazioni settimanali.

*Display with 3 keys, simple but functional with 2 weekly programmes.*

Display 3 teclas, simple pero funcional con 2 programaciones semanales.





# BABY 5



kW 6



kg 46

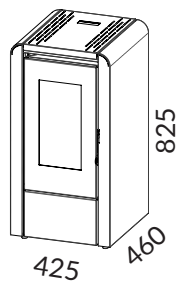

Nero / Black / Negro

Bordeaux\* / Bordeaux\* / Burdeos\*



Le sue ridotte dimensioni permettono al modello BABY di poter essere posizionato anche negli ambienti più piccoli.  
*Its small size allows the BABY model to be installed even in the smallest spaces.*

Su pequeño tamaño permite colocar el modelo BABY en habitaciones pequeñas.

Il serbatoio del pellet può contenere oltre 11 kg di pellet.  
*The pellet tank can hold up to more than 11 kg of pellets.*  
El depósito de pellets puede contener más de 11 kg de pellets.



\*Colore disponibile solo su richiesta  
\*Color available only on request  
\*Color disponible solo bajo pedido







# AURA 9



kW 8,5



kg 65

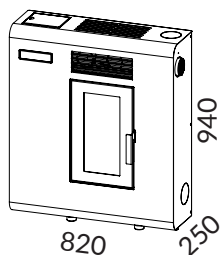

on request



Nero / Black / Negro



Bianco / White / Blanco



Il modello AURA 9 grazie alla sua profondità ridotta può essere inserito in spazi molto ristretti.

*Due to its very reduced depth the model AURA 9 can be placed in very tight spaces.*

El modelo AURA 9, de dimensiones estrechas, puede insertarse en espacios muy reducidos.

Il modello AURA 9 consente di riscaldare 2 ambienti contemporaneamente.

*The model AURA 9 lets you heat 2 room/spaces simultaneously.*

El modelo AURA 9 permite calentar 2 ambientes contemporaneamente.





# FLAMMY 7000



kW 7



kg 56



420 220



Pulizia del vetro facile da eseguire.  
*Glass cleaning easy to perform.*  
*Fácil de realizar la limpieza de cristales.*



Sistema di carico pellet facile e veloce.  
*Easy and quick pellet loading system.*  
*Carga de pellets rápida y sencilla.*



Svuotamento cenere automatico e posacenere estraibile.  
*Automatic Ash Emptying and Removable Ashtray*  
*Vaciado automático de cenizas y cenicero extraíble*

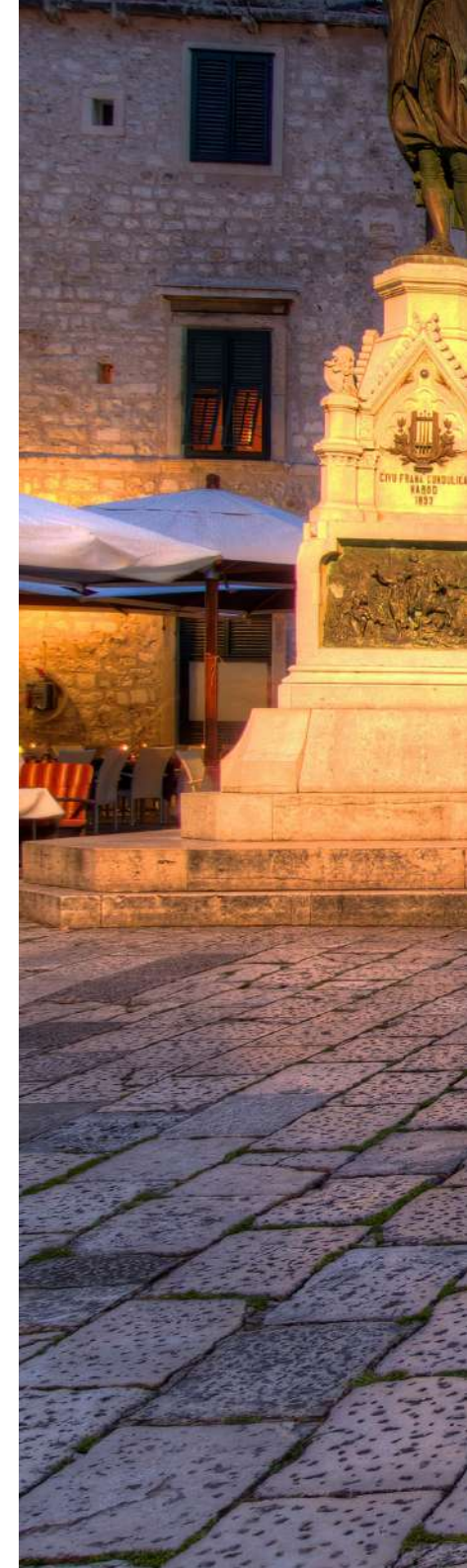



# FLAMMY 7000 PLUS



kW 7



kg 76

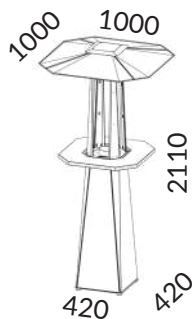

Ampio raggio d'azione grazie alla grande cupola.  
*Wide range of action thanks to the Large Dome.*  
Amplio rango de acción gracias a la gran cúpula.



Con tavolo integrato.  
*With Built-in Table.*  
Con mesa de centro incorporada.





# ALADINO 4000/4000 PLUS



kW 4



kg 28

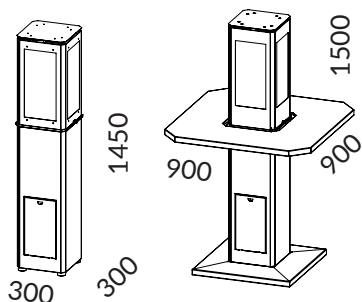

Caricamento pellet dall'alto facile e veloce.  
*Easy and quick pellet loading from above.*  
Carga rápida y fácil de pellets desde arriba.



Svuotamento cenere automatico e posacenere estraibile.  
*Automatic Ash Emptying and Removable Ashtray.*  
Vaciado automático de cenizas y cenicero extraíble.







# Dati tecnici / *Technical datas* / Datos técnicos

		ER 11X		ESC 13		ER 13		ESA 13		ES 13	
		max	min	max	min	max	min	max	min	max	min
Potenza termica globale <i>Overall thermal power / Potencia calorífica global</i>	kW	8,8	3,7	9,8	3,5	9,8	3,5	9,8	3,5	9,8	3,5
Potenza termica nominale <i>Rated thermal power / Potencia calorífica nominal</i>	kW	8,1	3,6	8,7	3,2	8,7	3,2	8,7	3,2	8,7	3,2
Efficienza <i>Efficiency / Rendimiento</i>	%	96,1	92,3	94,0	88,9	94,0	88,9	94,0	88,9	94,0	88,9
Emissioni CO al 13% O <sub>2</sub> <i>CO emission at 13% O<sub>2</sub> / CO emisión at 13% O<sub>2</sub></i>	mg/m <sup>3</sup>	275	123	118	98	118	98	118	98	118	98
Consumo orario <i>Hourly Consumption / Consumo por hora</i>	kg/h	1,8	0,8	2,0	0,7	2,0	0,7	2,0	0,7	2,0	0,7
Autonomia <i>Autonomy / Autonomía</i>	h	22,5	9,6	20,7	7,3	20,7	7,3	20,7	7,3	20,7	7,3
Consumo elettrico <i>Electrical consumption / Consumo de energía</i>	W	270	65	290	70	290	70	290	70	290	70
Diametro uscita fumi Ø <i>Smoke outlet connection Ø / Salida de humos Ø</i>	mm	80		80		80		80		80	
Diametro tubo asp.aria Ø <i>Air inlet connection Ø / Entrada aire de combustión Ø</i>	mm	50		50		50		50		50	
Capacità serbatoio <i>Tank capacity / Capacidad del depósito</i>	kg	17,5		17,5		17,5		17,5		17,5	
Peso <i>Weight / Peso</i>	kg	85		75		85		89		69	
Dimensioni <i>Dimensions / Dimensiones</i>	mm	585x1015x550		470x1020x505		585x1015x550		470x1020x500		475x1035x515	



WO 135		ES 11		WO 115		ER 14 ER 14C		RT 145E RT 145EC		WO 70		BABY 5		AURA 9	
max	min	max	min	max	min	max	min	max	min	max	min	max	min	max	min
9,8	3,5	8,5	3,5	8,5	3,5	11,6/11,0	4,6/4,9	11,6/11,0	4,6/4,9	6,7	2,9	5,6	2,5	9,0	3,6
8,7	3,2	7,7	3,2	7,7	3,2	10,3/9,7	4,2/4,5	10,3/9,7	4,2/4,5	5,9	2,7	5,0	2,3	7,9	3,4
94,0	88,9	94,0	90,6	94,0	90,6	90,4/91,7	89,0/88,1	90,4/91,7	89,0/88,1	90,7	87,2	89,7	88,2	93,2	88,2
118	98	118	72	118	72	80/58	78/42	80/58	78/42	159	63	130	71	136	132
2,0	0,7	1,8	0,7	1,8	0,7	2,4/2,3	1,0/1,0	2,4/2,3	1,0/1,0	1,4	0,6	1,2	0,5	1,9	0,8
20,7	7,3	20,7	8,4	20,7	8,4	18,2/17,3	7,2/7,6	18,2/17,3	7,2/7,6	24,2	10,6	21,7	9,8	15,8	6,4
290	70	290	68	290	68	310/300	140/125	310/300	140/125	270	75	290	45	290	110
80		80		80		80		80		80		80		80	
50		50		50		50		50		-		-		-	
17,5		17,5		17,5		17,5		17,5		15		11,5		12	
77		69		77		96-98		94 - 96		60		46		65	
535x1015x550		475x1035x515		535x1015x550		620x1090x590		550x1100x590		515x975x510		425x825x460		820x940x250	



# Dati tecnici / *Technical datas* / Datos técnicos

		FLAMMY 7000	FLAMMY 7000 PLUS	ALADINO 4000	ALADINO 4000
Combustibile <i>Fuel / Combustible</i>		Pellet	Pellet	Pellet	Pellet
Autonomia <i>Autonomy / Autonomía</i>	h	5/6	5/6	4/5	4/5
Raggio d'azione <i>Heatable space / Radio de action</i>	m	4	4	2	2
Potenza termica globale <i>Overal thermal power / Potencia calorífica global</i>	kW	7	7	4	4
Carica Pellet <i>Pellet capacity / Carrga de pellet</i>	kg	7,5	7,5	4,5	4,5
Alimentazione <i>Power / Alimentacion</i>		Batteria Ricaricabile Rechargeable battery Bateria recargable	Batteria Ricaricabile Rechargeable battery Bateria recargable	Batteria Ricaricabile Rechargeable battery Bateria recargable	Batteria Ricaricabile Rechargeable battery Bateria recargable
Batteria <i>Battery / Bateria</i>	Volt	12	12	12	12
Peso <i>Weight / Peso</i>	kg	56	76	28	53
Dimensioni <i>Dimensions / Dimensiones</i>	mm	420x2110x420	1000x2110x1000	300x1450x300	900x1500x900







## ESPERIA TECHNOLOGY

Via Dell'Impresa 31/33  
36040 Brendola (VI)  
Tel. +39 0444 401510  
[www.extrastove.it](http://www.extrastove.it)  
[info@extrastove.it](mailto:info@extrastove.it)

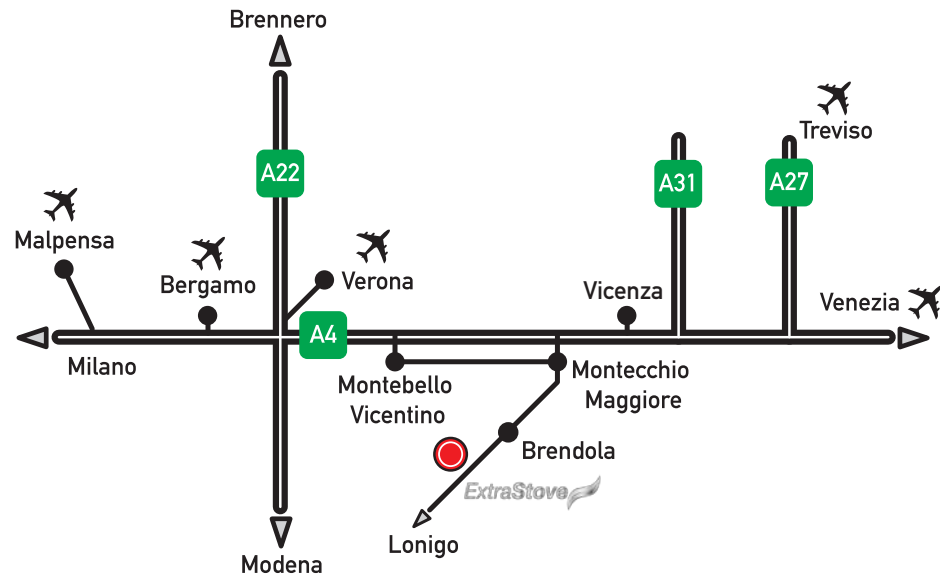





*ExtraStove* 



[www.extrastove.com](http://www.extrastove.com)

MADE IN ITALY